

IEC Appliance Inlet C20 with Circuit Breaker TA45



See below:
[Approvals and Compliances](#)

Description

- Panel mount :
 Screw-on version from front or rear side, snap-in version from front side
- 2 Functions :
 Appliance Inlet Protection class I , circuit breaker type TA45 2-pole
- Quick connect terminals 6.3 x 0.8 mm

Characteristics

- All single elements are already wired
- Unwired versions available on request
- Circuit Breaker non-illuminated or illuminated
- Suitable for use in equipment according to IEC/UL 60950

Other versions on request

- Unwired versions
- Variant with notch for V-Lock mating Cordsets

References

Alternative: version with line filter [EF12](#)

Weblinks

[pdf datasheet](#), [html-datasheet](#), [General Product Information](#), [Distributor-Stock-Check](#), [Accessories](#), [Detailed request for product](#), [Microsite](#)

Newly available variants corresponding to V-Lock mating cordset. The connector is equipped with a notch intended for use with the latching cordset. The cord latching system prevents against accidental removal of the cordset.

Technical Data

Ratings IEC	16A / 250VAC; 50Hz	appliance inlet/-outlet	C20 acc. to IEC 60320-1, UL 60320-1, CSA C22.2 no. 60320-1 (for cold conditions) pin-temperature 70 °C, 16A, Protection Class I
Ratings UL/CSA	20A / 250VAC; 60Hz	Circuit Breakers	Acc. IEC/EN 60934, UL 1077, CSA 22.2 no. 235 2-pole rocker switch, illuminated or non-illuminated. Optional with undervoltage- or remote trip release Short circuit capacity Icn: at In < 3A/240VAC : 10 x In at In ≥ 3A/240VAC : 300A
Dielectric Strength	> 1.5 kVAC between L-N > 3 kVAC between L/N-PE (1 min/50Hz)		
Allowable Operation Temperature	-10 °C to 55 °C		
IP-Protection	from front side IP 40 acc. to IEC 60529		
Insulation cover	Suitable for appliances with protection class I acc. to IEC 61140		
Terminal	Quick connect terminals 6.3 x 0.8 mm		
Panel Thickness S	Screw: max 8 mm Mounting screw torque max 0.5Nm Snap-in: 1.5/2/2.5 mm		
Material: Housing	Thermoplastic, black, UL 94V-0		

Approvals and Compliances

Detailed information on product approvals, code requirements, usage instructions and detailed test conditions can be looked up in [Details about Approvals](#)

Approvals



The approval mark is used by the testing authorities to certify compliance with the safety requirements placed on electronic products.

Approval Reference Type: EF11

Approval Logo	Certificates	Certification Body	Description
	VDE Approvals	VDE	Certificate Number: 40001029
	UL Approvals	UL	UL File Number: E96454

Product standards

Product standards that are referenced

Organization	Design	Standard	Description
	Designed according to	IEC 60320-1	Appliance couplers for household and similar general purposes
	Designed according to	UL 60320-1	Standard for Attachment Plugs and Receptacles
	Designed according to	CSA C22.2 no. 60320-1	General Use Receptacles, Attachment Plugs, and Similar Wiring Devices





Application standards

Application standards where the product can be used

Organization	Design	Standard	Description
	Designed for applications acc.	IEC/UL 60950	IEC 60950-1 includes the basic requirements for the safety of information technology equipment.

Compliances

The product complies with following Guide Lines

Identification	Details	Initiator	Description
	CE declaration of conformity	SCHURTER AG	The CE marking declares that the product complies with the applicable requirements laid down in the harmonisation of Community legislation on its affixing in accordance with EU Regulation 765/2008.
	RoHS	SCHURTER AG	EU Directive RoHS 2011/65/EU
	China RoHS	SCHURTER AG	The law SJ / T 11363-2006 (China RoHS) has been in force since 1 March 2007. It is similar to the EU directive RoHS.
	REACH	SCHURTER AG	On 1 June 2007, Regulation (EC) No 1907/2006 on the Registration, Evaluation, Authorization and Restriction of Chemicals 1 (abbreviated as "REACH") entered into force.
	MicrositeV-Lock	SCHURTER AG	V-Lock system are based on a matching plug-dose combination. The connector is equipped with a notch intended for use with the latching cordset. The cord latching system prevents against accidental removal of the cordset.

Dimensions [mm]

Screw-on mounting

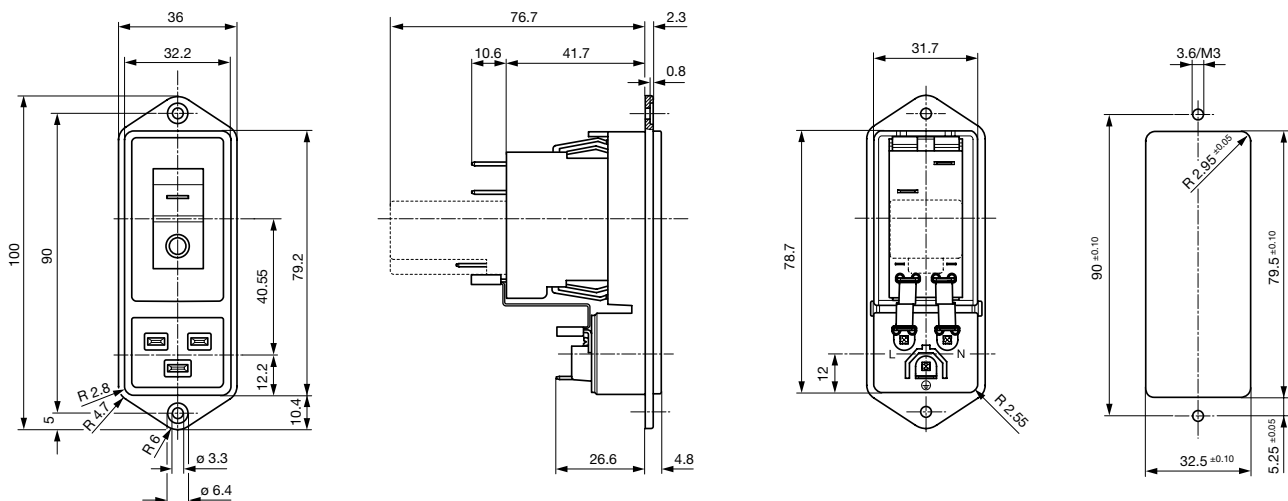

** --- Version TA45 with undervoltage release

Snap-in mounting

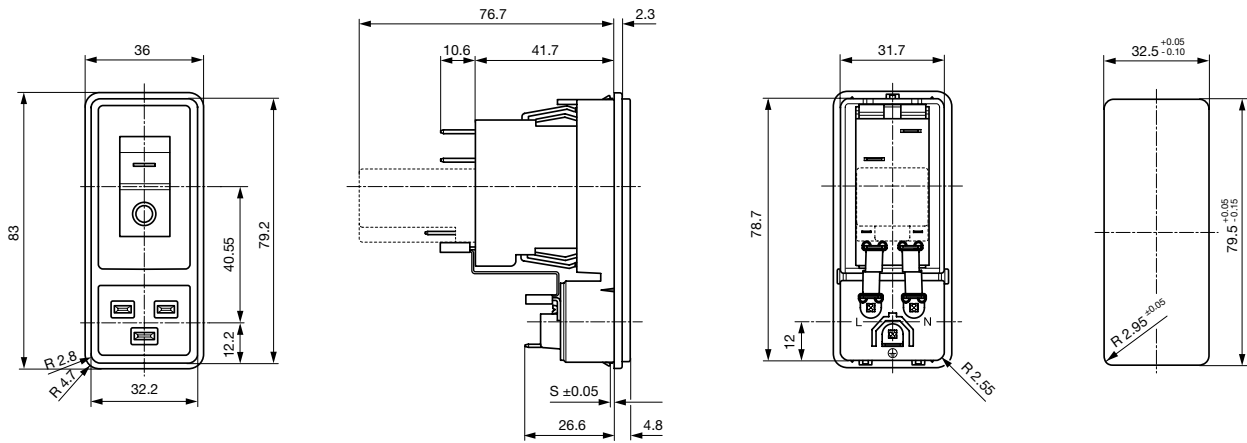

**--- Version TA45 with undervoltage release

Diagrams

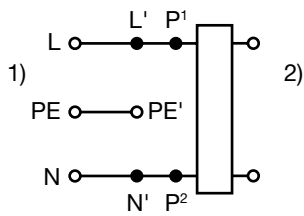

- 1) Line
- 2) Load

Time-Current-Curves

Tripping Characteristics $I_n < 3 A$

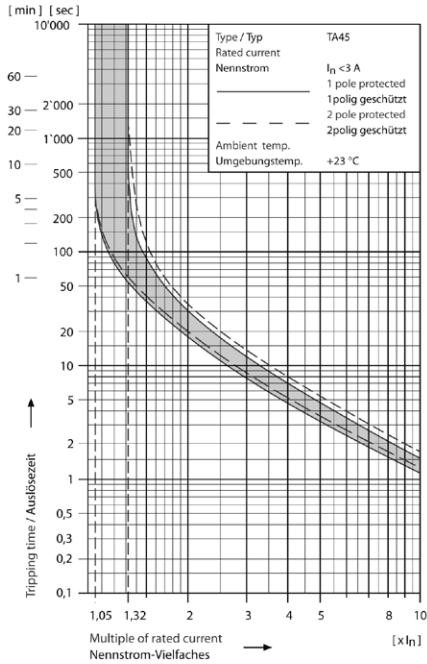

Tripping Characteristics $I_n \geq 3 \dots < 18 A$

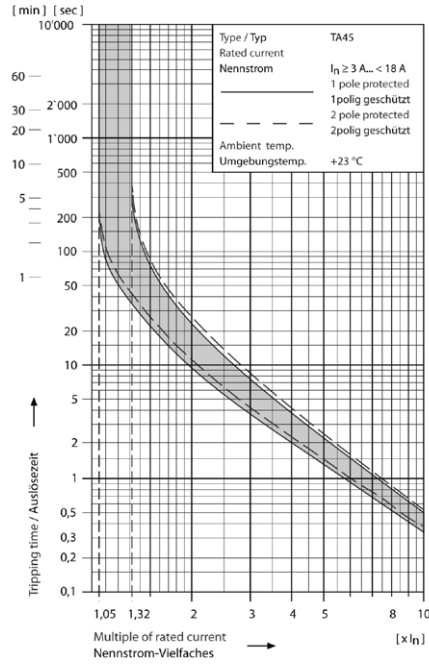

Tripping Characteristics $I_n \geq 18 A$

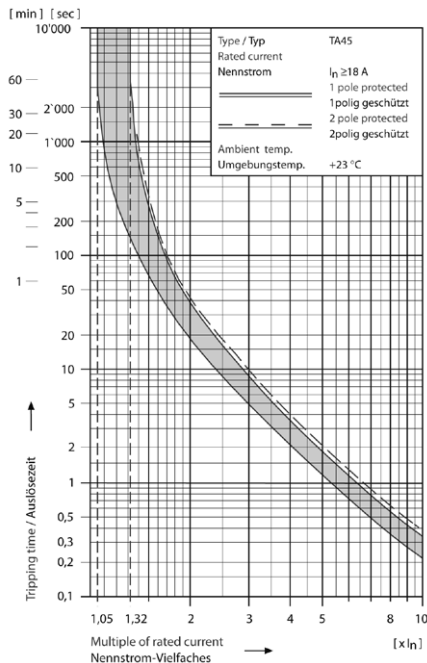
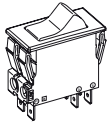

Table 1 Selection for type TA45

Order example



- Circuit Breaker of Equipment
 - 2-pole, rocker actuated
 - Quick connect terminal
- Other variants on request

ABT **W** **F** **150** **C0**

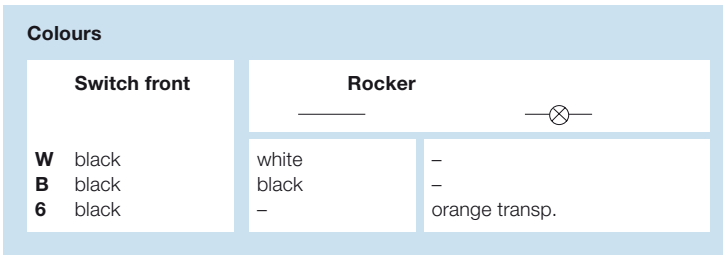
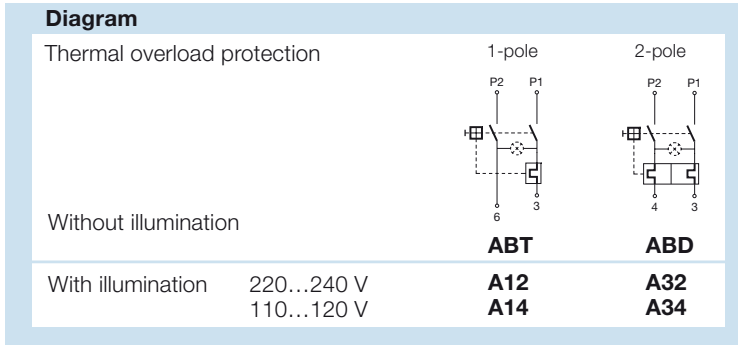

Rocker legend

Surface	Illustration	Colour of print	Surface	Illustration	Colour of print
F embossed	— ○		M printed	— ○	black
H printed	ON OFF	white	P printed	I ○	white
K printed	ON OFF	black	R printed	I ○	black
L printed	— ○	white			

Position of the rocker legend
e.g F

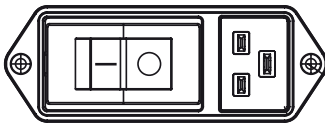

Rated current circuit breaker of equipment

I_n	Code	I_n	Code	I_n	Code	I_n	Code
10,0	100	13,0	130	16,0	160	19,0	190
11,0	110	14,0	140	17,0	170	20,0	200
12,0	120	15,0	150	18,0	180		

Other rated currents on request

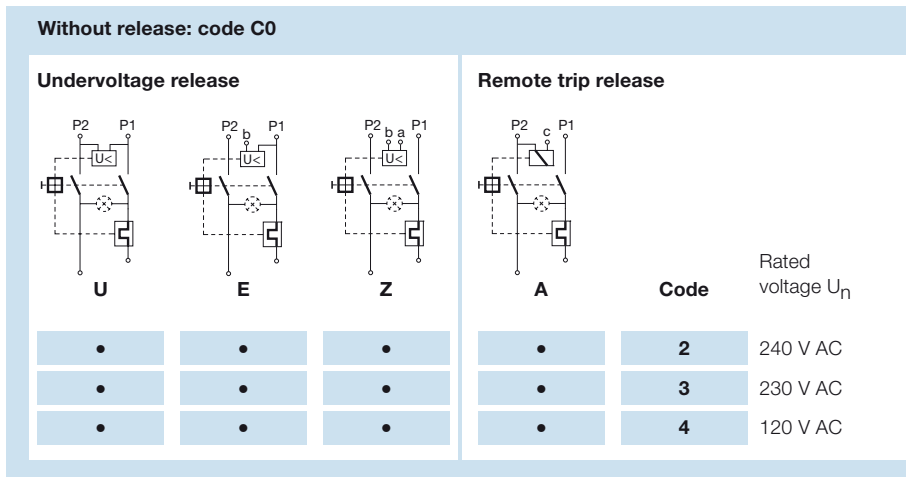

Technical data (continued)
Circuit breaker

Tripping characteristics
 $I_n < 3 A$

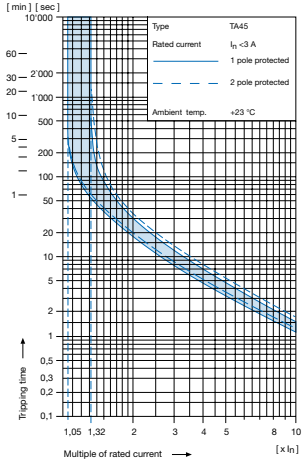

Tripping characteristics
 $I_n \ge 3... < 18 A$

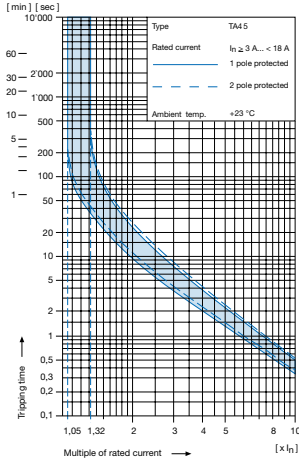

Tripping characteristics
 $I_n \ge 18 A$

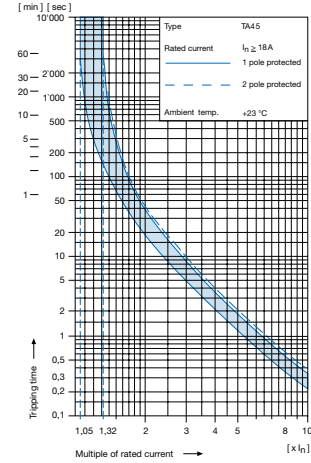

1) Effect of ambient temperature

The unit is calibrated for an ambient temperature of +23 °C. To determine the rated current for a lower or higher ambient temperature, use a correction factor from the table below:

* Ambient temperature [°C]	Correction factor
-10	0,89
- 5	0,91
0	0,92
+23	1,00
+30	1,03
+40	1,08
+55	1,16

* Temperature must be measured at the rear of the breaker next to the terminals after equipment operating temperature has been reached.

1) Example

Rated current at +23 °C	6,0 A
Ambient temperature	+40 °C
Correction factor	1,08
Chosen rated current at +40 °C ambient temperature	6 A x 1,08 = 6,5 A

Configuration code (example)

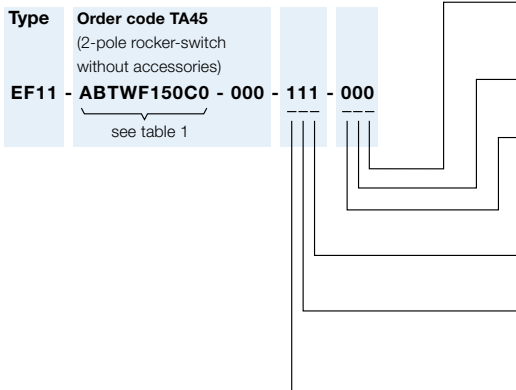

Optional Variants

- 0 standard
- 9 V-Lock notch

Colour

- 0 black

Mounting

- 0 Screw mounting
- 2 Snap-in mounting s = 1.5
- 3 Snap-in mounting s = 2.0
- 4 Snap-in mounting s = 2.5

Terminal PE

- 1 Quick-connect terminals 6.3x0.8mm

Terminal N

- 1 Quick-connect terminals 6.3x0.8mm, without connection to TA45
- 3 connection to TA45 non insulated

Terminal L

- 1 Quick-connect terminals 6.3x0.8mm, without connection to TA45
- 3 connection to TA45 non insulated

Packaging unit 16 Pcs

Accessories

Description

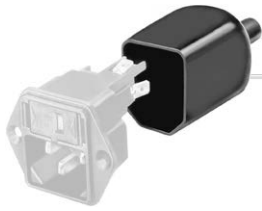

Assorted Covers
 Rear Cover

0859.0109



Cord retaining kits
 Cord retaining strain relief

Flat head, H

4700.0008

Mating Outlets/Connectors

Category / Description



Connector Overview complete

IEC Connector C19, Rewireable, Straight

4795

IEC Connector C19, Rewireable, Angled

4790

Connector further types to EF11

Power Supply Cord Overview complete



Cord Sets 10 A, North America, 3.0 m, Connector IEC C13, SJT 3x18 AWG, Transparent

4300.0920

Cord Sets 16 A, Europlug, 2.5 m, Connector IEC C19, H05VV-F3G1.5, black

6004.0395

Cord Sets 16 A, Interconnection, 1.0 m, Connector IEC C19, H05VV-F3G1.5, black

6020.0392

Cord Sets 16 A, Interconnection, 2.0 m, Connector IEC C19, H05VV-F3G1.5, black

6020.0394

Cord Sets 16 A, North America, 2.5 m, Connector IEC C19, SJT 3x14 AWG, black

6009.5195

Power Supply Cord further types to EF11

Mating Outlets/Connectors shuttered



Power Cord Overview complete

Overview Power Cord with IEC Appliance Connector C19, V-Lock, straight

VAC19KS

Power Cord further types to EF11