

IEC Appliance Inlet C8 polarized, Snap-in Mounting, Front Side, Solder, Quick Connect or PCB Terminal



Snap-in mounting from front side
 Solder terminal for PCB
 Terminal vertical

C8 polarized



70 °C

See below:

[Approvals and Compliances](#)

Description

- Panel mount
- Snap-in mounting on PCB from front side
- Appliance Inlet , Pin temperature 70 °C , Protection class II
- Solder, Quick Connect or PCB Terminal

Weblinks

[pdf data sheet](#), [html datasheet](#), [General Product Information](#), [Distributor-Stock-Check](#), [Accessories](#), [Detailed request for product](#)

Technical Data

Ratings IEC	2.5 A / 250 VAC; 50 Hz	appliance inlet/-outlet	C8p acc. to IEC 60320-1 UL 60320-1, CSA C22.2 no. 60320-1 (for cold conditions) pin-temperature 70 °C, 2.5 A, Protection Class II
Ratings UL/CSA	2.5 A / 250 VAC; 60 Hz		
	7 A / 125 VAC; 60 Hz		
Dielectric Strength	> 1.5 kVAC between L-N > 3 kVAC between L/N-PE (1 min/50 Hz)		
Allowable Operation Temperature	-25 °C to 70 °C		
IP-Protection	from front side IP20 acc. to IEC 60529		
Protection against electric shock	Suitable for appliances with protection class II acc. to IEC 61140		
Material: Housing	PA6, black / grey / white, UL 94V-0		

Approvals and Compliances

Detailed information on product approvals, code requirements, usage instructions and detailed test conditions can be looked up in [Details about Approvals](#)

SCHURTER products are designed for use in industrial environments. They have approvals from independent testing bodies according to national and international standards. Products with specific characteristics and requirements such as required in the automotive sector according to IATF 16949, medical technology according to ISO 13485 or in the aerospace industry can be offered exclusively with customer-specific, individual agreements by SCHURTER.

Approvals

The approval mark is used by the testing authorities to certify compliance with the safety requirements placed on electronic products.

Approval Reference Type: 2579

Approval Logo	Certificates	Certification Body	Description
	VDE Approvals	VDE	VDE Certificate Number: 40034368
	UL Approvals	UL	UL File Number: E96454

Product standards

Product standards that are referenced

Organization	Design	Standard	Description
	Designed according to	IEC 60320-1	Appliance couplers for household and similar general purposes
	Designed according to	UL 60320-1	Standard for Attachment Plugs and Receptacles
	Designed according to	CSA C22.2 no. 60320-1	General Use Receptacles, Attachment Plugs, and Similar Wiring Devices





Application standards

Application standards where the product can be used

Organization	Design	Standard	Description
	Designed for applications acc.	IEC/UL 60950	IEC 60950-1 includes the basic requirements for the safety of information technology equipment.

Compliances

The product complies with following Guide Lines

Identification	Details	Initiator	Description
	CE declaration of conformity	SCHURTER AG	The CE marking declares that the product complies with the applicable requirements laid down in the harmonisation of Community legislation on its affixing in accordance with EU Regulation 765/2008.
	RoHS	SCHURTER AG	Directive RoHS 2011/65/EU, Amendment (EU) 2015/863
	China RoHS	SCHURTER AG	The law SJ / T 11363-2006 (China RoHS) has been in force since 1 March 2007. It is similar to the EU directive RoHS.
	REACH	SCHURTER AG	On 1 June 2007, Regulation (EC) No 1907/2006 on the Registration, Evaluation, Authorization and Restriction of Chemicals 1 (abbreviated as "REACH") entered into force.

Dimensions [mm]

Solder terminals for PCB

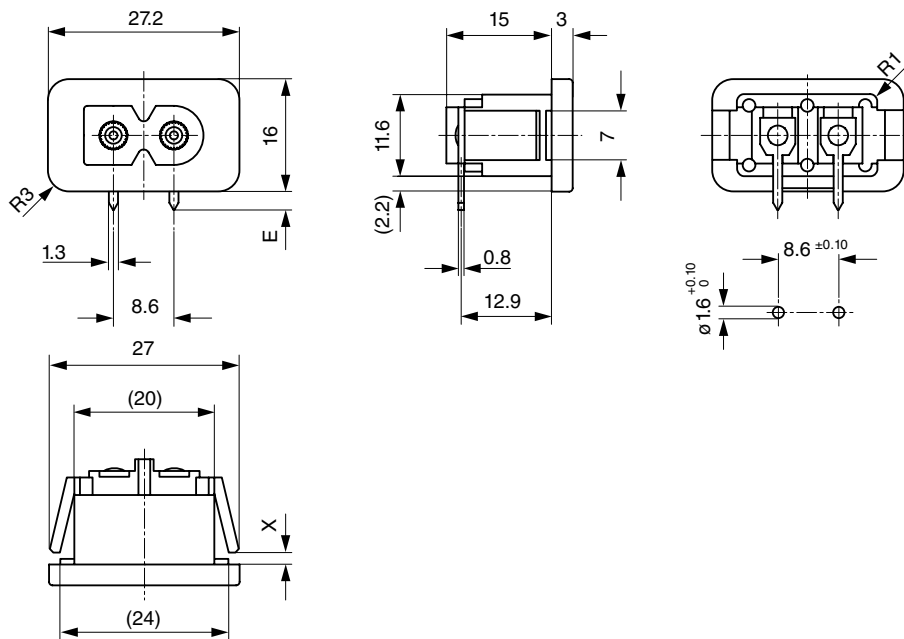

- Panel thickness X = 1.0 / 1.5 / 2.0 / 2.5 / 3.0 mm
- E: PCB terminal standard: 4.25 mm
- E: PCB terminal short: 2.7 mm
- E: PCB terminal long: 5.35 mm

Terminals orientation A

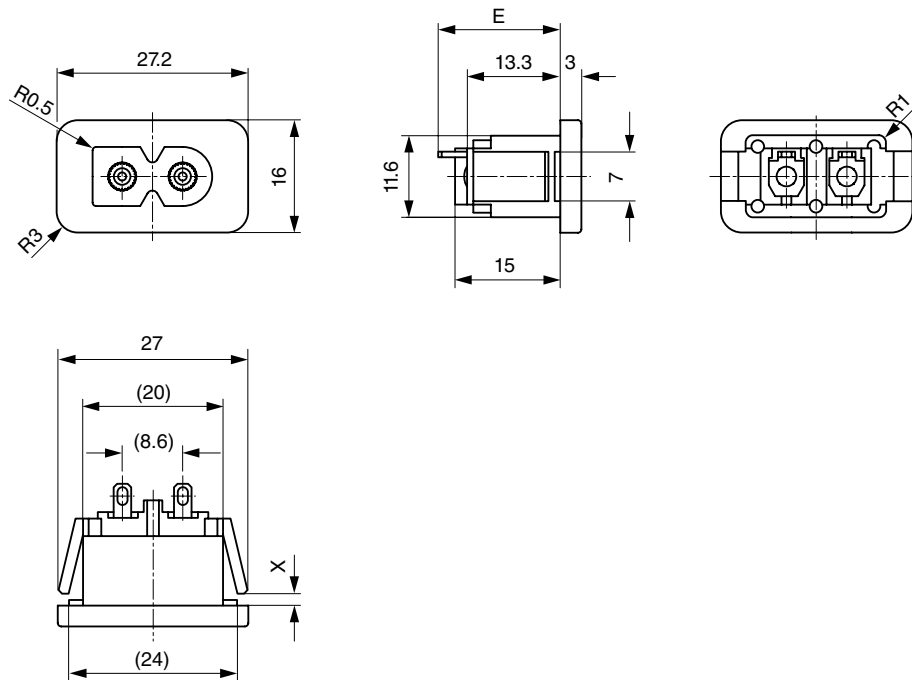

Panel thickness X = 1.0 / 1.5 / 2.0 / 2.5 / 3.0 mm
 E: Solder terminals short: 17.3 mm (L=4.8 mm)
 E: Solder terminals long: 21.0 mm (L=8.5 mm)
 E: Quick connect terminals 2.8x0.8 mm: 23.3 mm

Terminals orientation B

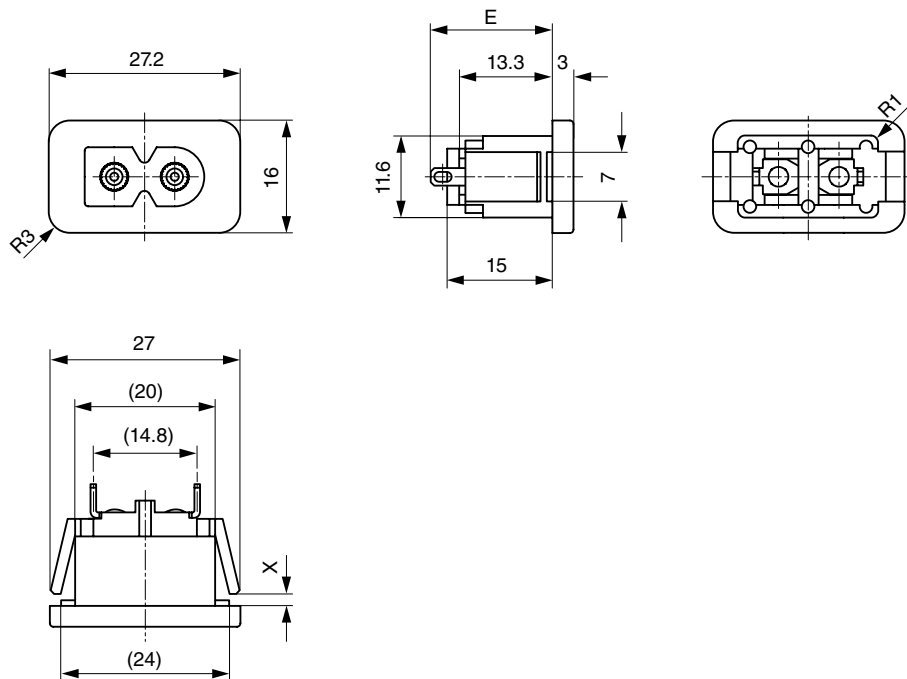

Panel thickness X = 1.0 / 1.5 / 2.0 / 2.5 / 3.0 mm
 E: Solder terminals short: 17.3 mm (L=4.8 mm)
 E: Solder terminals long: 21.0 mm (L=8.5 mm)
 E: Quick connect terminals 2.8x0.8 mm: 23.3 mm

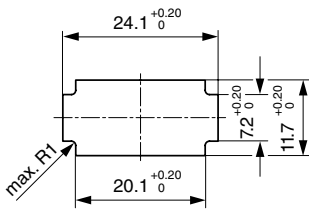

Panel cut-out for X = 1.0 mm

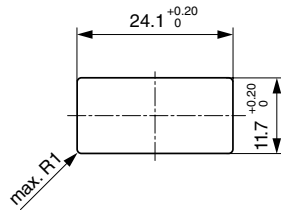

Panel cut-out for X = 1.5 / 2.0 / 2.5 / 3.0 mm

Config. Code

2579 - H - A B C 0 - D - E G F

The characters are placeholders for the correspondingly keys of selections from the key tables.

2579 - **H** - A B C 0 - D - E G F = Type











Type	Configuration key
protection class II	X

Terminal L

Configuration key

PCB-terminal (long)	 C
---------------------	---

2579 - H - **A** B C 0 - D - E G F = Terminals

Terminal L	Configuration key
short solder terminal (L = 4.8 mm)	 2
long solder terminal (L = 8.5 mm)	 3
PCB-terminal standard (additional solder terminal)	 4
PCB-terminal short (additional solder terminal)	 5
PCB-terminal long (additional solder terminal)	 6
Blade terminal (2.8 x 0.8 mm)	 7
Blade terminal (4.8 x 0.8 mm)	 8
Blade terminal (6.3 x 0.8 mm)	 9
PCB-terminal (standard)	 A
PCB-terminal (short)	 B

2579 - H - A **B** C 0 - D - E G F = Terminals

Terminal N

Configuration key

short solder terminal (L = 4.8 mm)	2
long solder terminal (L = 8.5 mm)	3
PCB-terminal standard (additional solder terminal)	4
PCB-terminal short (additional solder terminal)	5
PCB-terminal long (additional solder terminal)	6
Blade terminal (2.8 x 0.8 mm)	7
Blade terminal (4.8 x 0.8 mm)	8
Blade terminal (6.3 x 0.8 mm)	9
PCB-terminal (standard)	A
PCB-terminal (short)	B
PCB-terminal (long)	C

Symbols similar as in table A

2579 - H - A B **C** 0 - D - E G F = Terminals

Terminal Ground

Configuration key

without terminal	0
------------------	---

Symbols similar as in table A

2579 - H - A B C 0 - **D** - E G F = Color

Color

Configuration key

Black	A
Grey	B
White	D

2579 - H - A B C 0 - D - E G F = Style

Style	Configuration key
snap-in (s=panel thickness)	4

2579 - H - A B C 0 - D - E G F = Dimension S

Dimension "S"	Configuration key
10	
15	
20	

The dimension "S" is displayed in (1/10 mm). This information is also valid for the order code

Dimension "S"

25
30

The dimension "S" is displayed in (1/10 mm). This information is also valid for the order code

Configuration key

2579 - H - A B C 0 - D - E G F = Orientation of Terminals

Orientation of Terminals	Configuration key
horizontal	A
vertical	B

All Variants

Terminals L / N	Orientation of Terminals	Color	Panel Thickness s [1/10 mm]	Config. Code	Order Number
short solder terminal (L = 4.8 mm)	vertical	Black	30	2579-X-2200-A-430B	6160.0140
PCB-terminal (standard)	horizontal	Black	30	2579-X-AA00-A-430A	6160.0141
short solder terminal (L = 4.8 mm)	horizontal	Black	30	2579-X-2200-A-430A	6160.0142
short solder terminal (L = 4.8 mm)	horizontal	Black	25	2579-X-2200-A-425A	6160.0145
short solder terminal (L = 4.8 mm)	vertical	Black	15	2579-X-2200-A-415B	6160.0150
short solder terminal (L = 4.8 mm)	vertical	Black	20	2579-X-2200-A-420B	6160.0151
short solder terminal (L = 4.8 mm)	vertical	Black	25	2579-X-2200-A-425B	6160.0152
short solder terminal (L = 4.8 mm)	horizontal	Black	15	2579-X-2200-A-415A	6160.0157
short solder terminal (L = 4.8 mm)	horizontal	Black	20	2579-X-2200-A-420A	6160.0158
PCB-terminal (standard)	horizontal	Black	15	2579-X-AA00-A-415A	6160.0159

The listed variants should be available from stock. Other versions on request www.schurter.com/contact

Availability for all products can be searched real-time: <https://www.schurter.com/en/Stock-Check/Stock-Check-SCHURTER>

Packaging unit 100 Pcs

Mating Outlets/Connectors

Category / Description



Power Supply Cord Overview complete

Cord Sets 2.5 A, North America, Black, 2.5 m, SVT 2x18AWG, IEC C7p, 002500 mm, SVT 2x18 AWG, black

6052.0047

Power Supply Cord further types to 2579