

Compensated High Current Choke, 1-phase



See below:
[Approvals and Compliances](#)

Description

- Current compensated choke
- 1-phase choke
- THT-terminals
- Flange for mounting onto printed circuit board
- Fully potted resin

Applications

- Placed in front of frequency converter
- Stepper motor drives
- UPS-systems
- Inverter

References

We recommend for new applications [DKIH-1](#)
 Last order date: 15.12.2018

Weblinks

[pdf data sheet](#), [html datasheet](#), [General Product Information](#), [Distributor-Stock-Check](#), [Detailed request for product](#)

Technical Data

Rated voltage	up to 540VAC up to 760VDC	Test Voltage	2.5kV, 50Hz, 2 sec, winding to winding
Rated Current	10 - 20A @ Ta 40 °C	Isolation Voltage	2.5kV eff., 50Hz, 2 sec, winding to ambient
Rated inductance	1.1 - 12mH, Tol. -30% +50%	Climatic Category	25/100/21 acc. to IEC 60068-1
Power Operating Frequency	50 - 400Hz	Allowable Operation Temp.	-25 °C to 100 °C
Terminal Type	THT		
Weight	145 - 525g		
Material: Housing	UL 94V-0		
Sealing Compound	UL 94V-0		

Approvals and Compliances

Detailed information on product approvals, code requirements, usage instructions and detailed test conditions can be looked up in [Details about Approvals](#)

SCHURTER products are designed for use in industrial environments. They have approvals from independent testing bodies according to national and international standards. Products with specific characteristics and requirements such as required in the automotive sector according to IATF 16949, medical technology according to ISO 13485 or in the aerospace industry can be offered exclusively with customer-specific, individual agreements by SCHURTER.

Approvals

The approval mark is used by the testing authorities to certify compliance with the safety requirements placed on electronic products.

Approval Reference Type: DKIL

Approval Logo	Certificates	Certification Body	Description
	UL Approvals	UL	UL File Number:





Application standards

Application standards where the product can be used

Organization	Design	Standard	Description
	Designed for applications acc.	IEC/UL 60950	IEC 60950-1 includes the basic requirements for the safety of information technology equipment.

Compliances

The product complies with following Guide Lines

Identification	Details	Initiator	Description
	CE declaration of conformity	SCHURTER AG	The CE marking declares that the product complies with the applicable requirements laid down in the harmonisation of Community legislation on its affixing in accordance with EU Regulation 765/2008.
	RoHS	SCHURTER AG	Directive RoHS 2011/65/EU, Amendment (EU) 2015/863
	China RoHS	SCHURTER AG	The law SJ / T 11363-2006 (China RoHS) has been in force since 1 March 2007. It is similar to the EU directive RoHS.
	REACH	SCHURTER AG	On 1 June 2007, Regulation (EC) No 1907/2006 on the Registration, Evaluation, Authorization and Restriction of Chemicals 1 (abbreviated as "REACH") entered into force.

Dimension [mm]

Case 31-2P

Case 46-2P

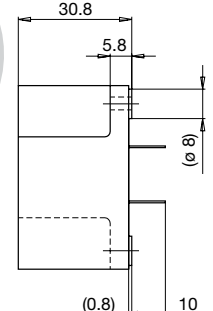
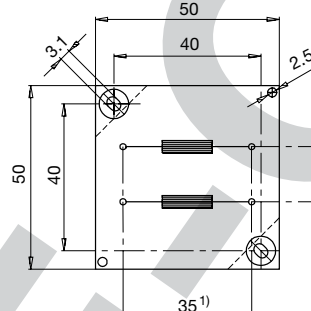
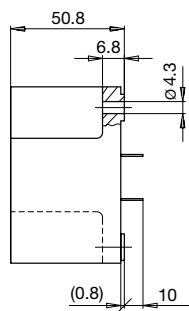
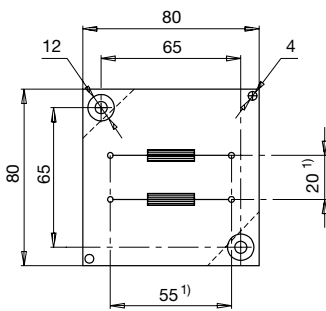

1) Spacing given at pin base

Impedance curves

DKIL-0231-xxxx

DKIL-0246-xxxx

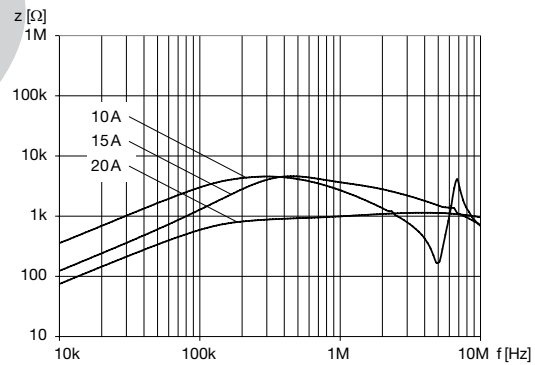
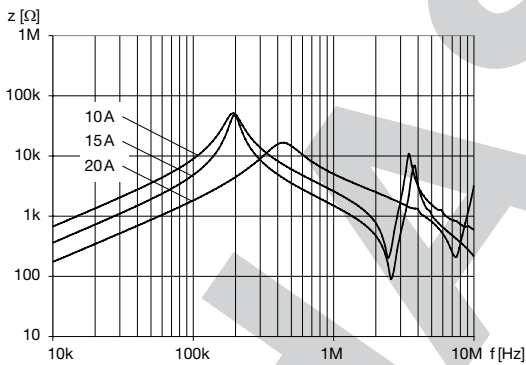

All Variants

I_n [A]	L_n [mH]	R_{cu} [mΩ]	Tripped Power Dissipation [W]	f_{RES} [MHz]	Copper ϕ [mm]	Weight [g]	Housings	Packing unit [pcs.]	Order Number
10	12	40	8	0.15	1.25	477 g	31-2P	2	DKIL-0231-1012
15	5	17	7.6	0.33	1.6	525 g	31-2P	2	DKIL-0231-1505
20	3	10	8	0.55	1.8	506 g	31-2P	2	DKIL-0231-2003
10	5	18	3.6	0.35	1.25	145 g	46-2P	10	DKIL-0246-1005
15	2	8	3.6	0.6	1.6	145 g	46-2P	10	DKIL-0246-1502
20	1.1	6	4.8	2.5	1.8	145 g	46-2P	10	DKIL-0246-2001

Availability for all products can be searched real-time: <https://www.schurter.com/en/Stock-Check/Stock-Check-SCHURTER>